

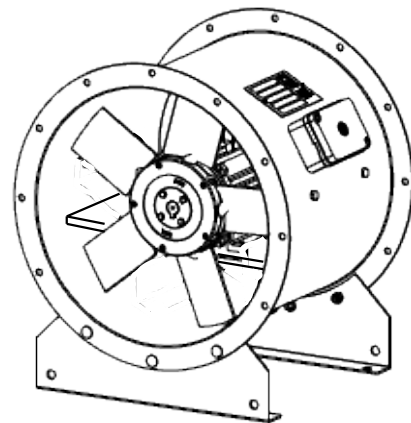

AIRVENT(AV)450

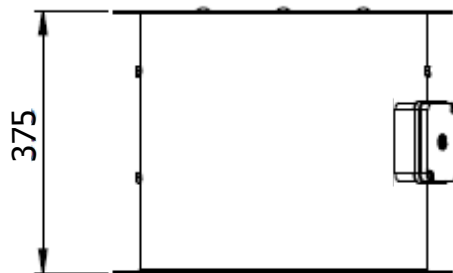
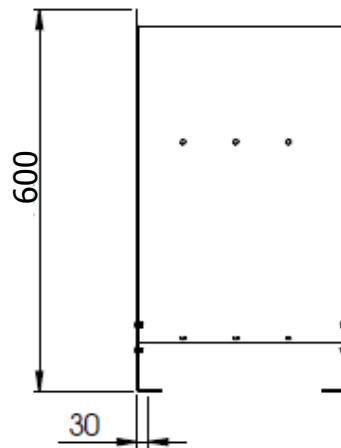
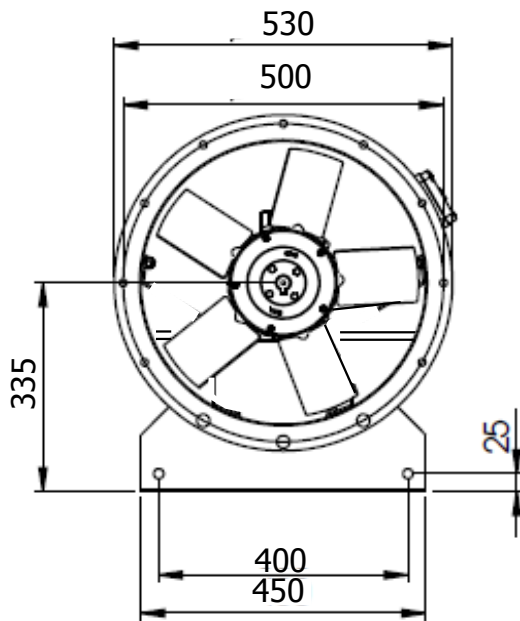

כל המידות במ"מ

Lazarov Street 5 ,New Industrial Area, Rishon Le Zion 75654, Israel
Tel: 00972-3-9617106 fax: 00972 3- 9616938 email: sagy@sagyvent.co.il